

**H56@9'C:7CBH9BHG**

Introduction .....	1
Electrical Design .....	2
Electrical 3D Part Design Toolbars .....	4
Electrical 3D Part Design .....	13
Mounting Equipment .....	13
Mounting Equipment with Cavity .....	14
Defining a Cavity .....	16
Mounting Equipment with Cavity Connection Point .....	24
Defining a Cavity Connection Point .....	25
Mounting Equipment with a Segment Connection Point .....	28
Defining a Segment Connection Point .....	29
Equipment .....	33
Shells .....	40
Shell Equipment with a Shell Connection Point .....	44
Defining a Shell Connection Point .....	45
Shell Equipment with a Back Shell Connection Point .....	49
Defining a Back Shell Connection Point .....	50
Connector .....	51
Single Insert Connector .....	51
Single Insert Connector with Connector Connection Point .....	52
Defining a Connector Connection Point .....	54
Stud, Terminal Strip, Terminal Block .....	59
Splice .....	63
Multi Insert Connectors .....	66
Contacts .....	69
Filler Plug .....	71
Back Shell .....	73
Protective Covering .....	79
Supports .....	84
Multi-Position Supports .....	90
Adaptive Supports .....	92
Electrical Catalogs .....	99
Catalog Environment .....	99
Catalog Editor Workbench .....	100
Catalog Structure .....	101
Chapters .....	101
Inserting Items .....	103
Keywords .....	105
Creating Keywords .....	105
Modifying Keywords .....	107

---

Electrical 3D Design .....	113
Assembling Electrical Devices .....	113
Electrical Assembly Constraints .....	120
Assembling Electrical Devices and Adding Connection Points .....	123
Assembling Electrical Devices Utilizing Catalogs .....	



(OHFWULFDO 'HVLJQ

(OHFWULFDO 'HŠKJQ/HRWGHILLQLQW DQVMOH%MIURLFDORX FDQ  
GHILQLQJ WKH ZLUH VHJPHQWV DQGHFWQIGFDOV SDRXWQHHTK M  
EXLOGGLQJ RI WKH SDUWV LV GRQVK ØŠ/H QHJMQ JQS DDQVG GRW/K H  
UHODWHG ZRUNEHQFKHV 2QFH WKHWRRGHJQ Q VG ŠHLYHLQR ŠMİK  
HOHFWULFDO SURSHUWLHV IRU WHKQ VL PRKGW ØH ŠQH ŠWUWF DW  
VKRXOG KDYH DOO QHFHVVDU\ HØ HWFUWUQ F DWOR SEJRLŠEJ W LKDWU

7KHUH DUH WKUHH VWDJHV WR Gwillllllllll DQZHDVHFWUØGDW K  
7KLV FDQ JHQHUDOO\ EH WKH PRQMHGLMRFØØWHDVŠ ØFVWVWKLH  
FRPSOH[LW\ IRU WKH SDUW 7KH KRUPRERPSØWDLØXØ DLNH Z  
EHFRPH DQG WKH PRUH LQIRUPDWLIRØKIRXS ØDØ ŠXVNLHQWRU  
H[DPSOH D VLPSOH HOHFWULFDO FRUG SOXJ

7KLV W\SH RI SOXJQFD ØHFWRRGHLOHGGLDH ØHØXP ØHHUURHHV RI  
FRPSOH[LW\ <RX FRXOG PRGHO WKIR ŠØXW ØHV ZLVHQFJØØHØH

The next level of complexity would be to indicate that the plug has three connection points.

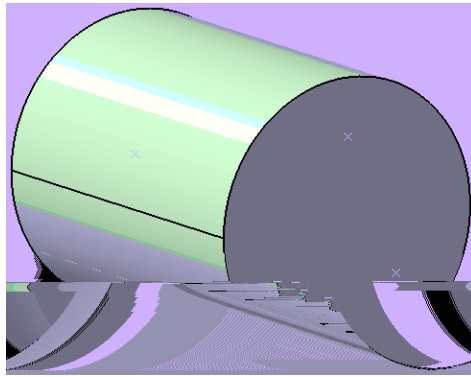

Although there is little change in the model, you will be able to define more information with the electrical terminations on this model, such as each specific termination and the route of the wire from pin to pin. There is not a high amount of part detail, but you will have a higher amount of electrical detail just by adding a few extra points in the model.

The highest level of detail would be to define the entire product.

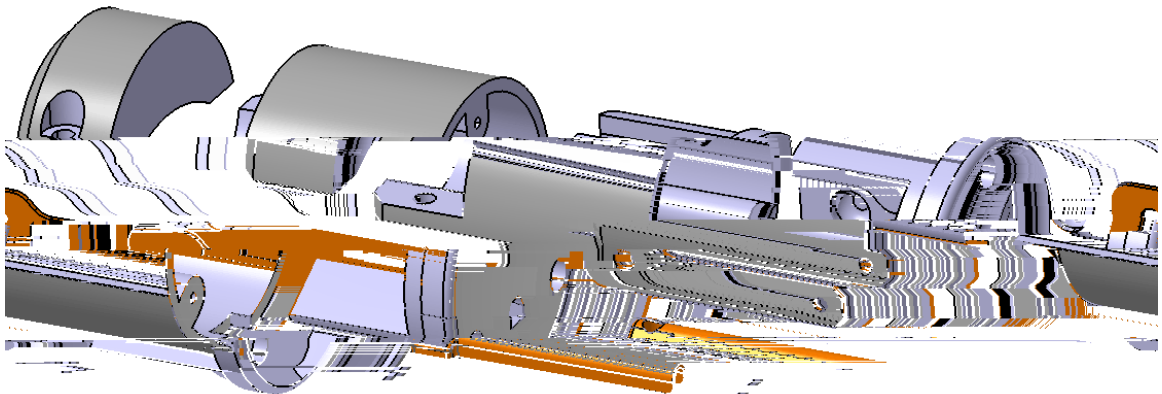



At this point, you would have a very high level of detail for both the digital design of the model and the electrical properties for this assembly. You would not only be able to define the contacts for the electrical part, but you would also be able to define the shells, back shells, supports, and all other components for the plug. Keep in mind, although this type of assembly does show and have the most detail, it also takes the longest to build.

When determining what you will need to build, be sure to take into account how much time you want to spend building the part, and what information you need to pull from the part. If you find you need a high level of information from the part, you will need to be highly detailed for the product.

In this course, you will utilize two electrical workbenches, along with all your part and assembly workbenches. It will be assumed that you have a good understanding of Part Design and Assembly Design, as well as some understanding of wireframe and surfaces. In this course you will primarily be using the Electrical 3D Part Design and Electrical 3D Design workbenches to electrify your parts and products.

**Ac i bh]b[ '9e i]d a Ybh' k]h\ '7U j]hm**

Mounting equipment with a cavity will generally be a mount of s

Select the **Ac i bh]b[ '9e i]d a Ybh** icon.  It is located within the sub-toolbar of the Backshell icon in the *Device* section.  This will change the part to mounting equipment. Equipment properties are always applied to the entire part. The *Mounting Equipment Definition* window appears, allowing you to change the name of the mounting equipment.

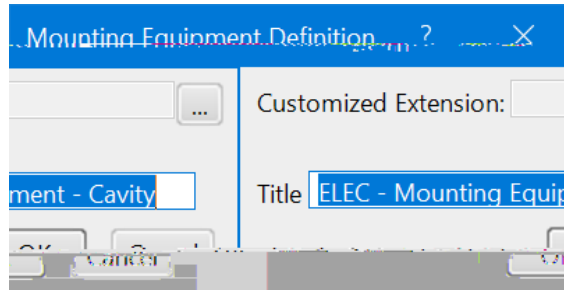

Change the *Title* to **ELEC - Gauge Mount** and select *OK*. In the tree, the name of the part at the instance level and its symbol have changed.



The part has been defined as an electrical device. Now you must define the electrical connection point.





Standard tab

*Axis System*

Places the cavity via a pre-existing axis system. You can also create a new axis system by selecting the icon next to this field.



Advanced tab

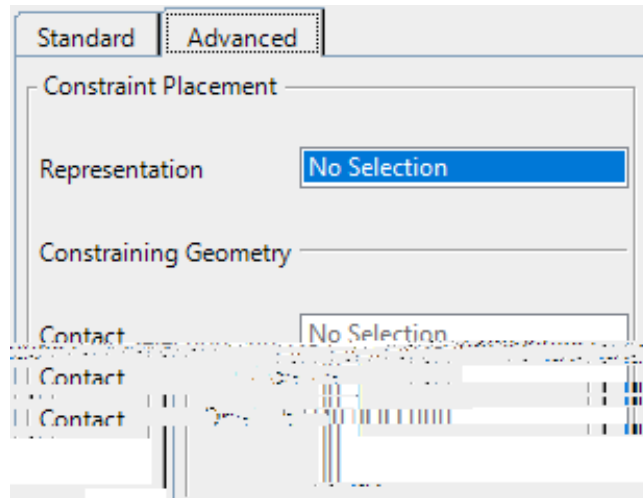

*Constraint Placement*

Uses existing features for the cavity's display

*Representation*

The geometry that will highlight when the cavity is selected; you can choose faces, geometrical elements, or sketch based features

*Constraining Geometry*

These fields define the cavity's placement

*Contact*

The surface that will touch the cavity connection point contact surface. When a planar face is selected, a contact constraint will be generated.

e-ex \$

*More >>* button

*Segment section parameters*

Defines the profile of the connected branches

*Width*

# *CATIA Electrical Design*

**Select OK.** The *Cavity Definition* window re-appears, and a green arrow labeled *Segment tangency* should be visible on the newly created axis, pointing in toward the part. If ever the green arrow is pointing opposite the desired direction, click the icon beside the *Axis System* field and select the *Reverse* checkbox beside the *X axis* field.

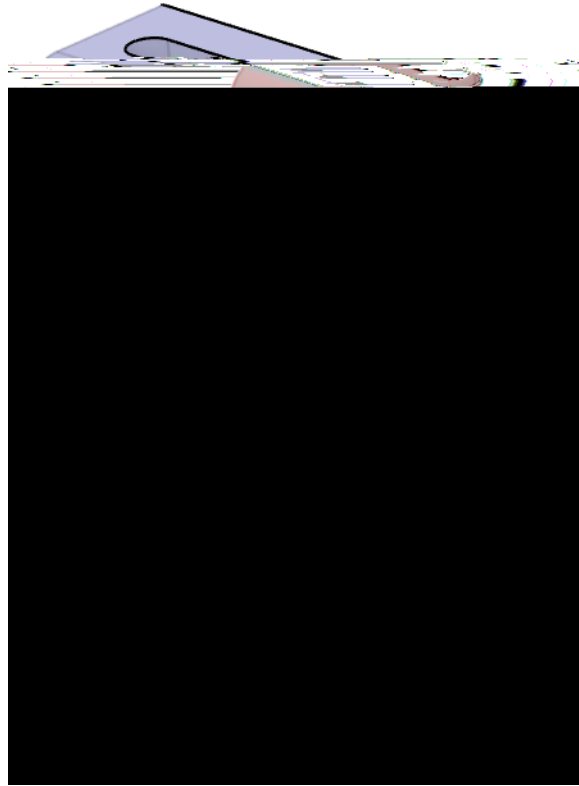

**Select Cancel.** You will now define the cavity from existing geometry.

Select the **7U jhm** icon, then select the part and change the name to **Gage Hole**. 

Select the *Advanced* tab, then select the inner surface of the large hole as the *Representation*. You can also select *Hole.2* from the specification tree. The *Representation* element will highlight when the cavity is selected.

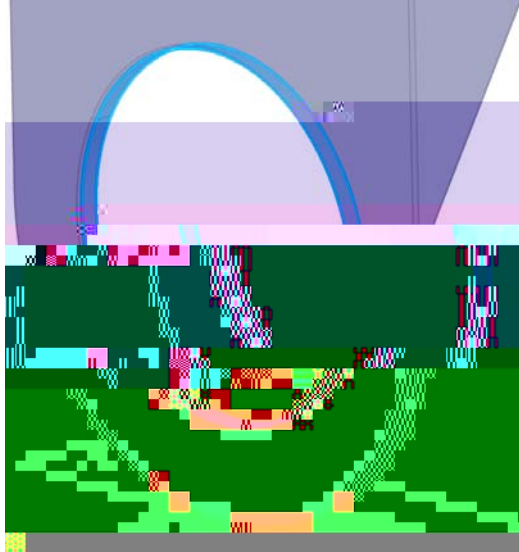

Next you will define the *Constraining Geometry*. This will define how the part will be constrained when it is electrically assembled to another part.

Select the face indicated below for the *Contact* field. The green arrow is pointing away from the part. When using the *Advanced* method, the direction of the *Segment tangency* arrow cannot be reversed.

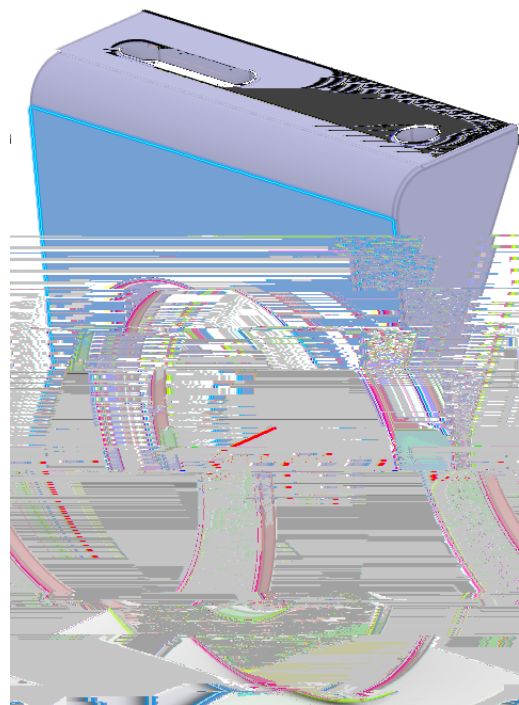



**Select Gauge Hole in the Electrical branch.** The geometry that was defined as the *Representation* highlights in the workspace.

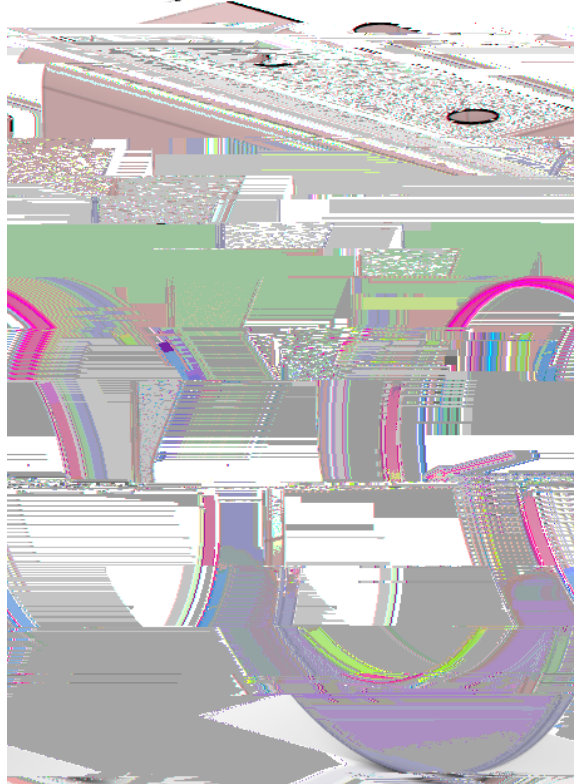

You should also notice the three new publication elements.



The first publication, *Gauge Hole*, is the publication of the electrical cavity definition. This publication will not be associated to any geometry. The other publications are for the placement constraint elements selected when defining the cavity. Since you only selected two elements for the placement constraints, only two publications were created. In this case, you have the face publication for the contact constraint and the axis constraint for the centerline coincidence.

At this point, you are done defining the mounting equipment electrical device.

**Save and close the document.** It is recommended that you save, since you can use the parts later.

**Multi insert connectors**

Multi insert connectors only allow for connections to single insert connectors and mounting equipment. Generally, multi insert connectors work good for “Y” adapters or splitters



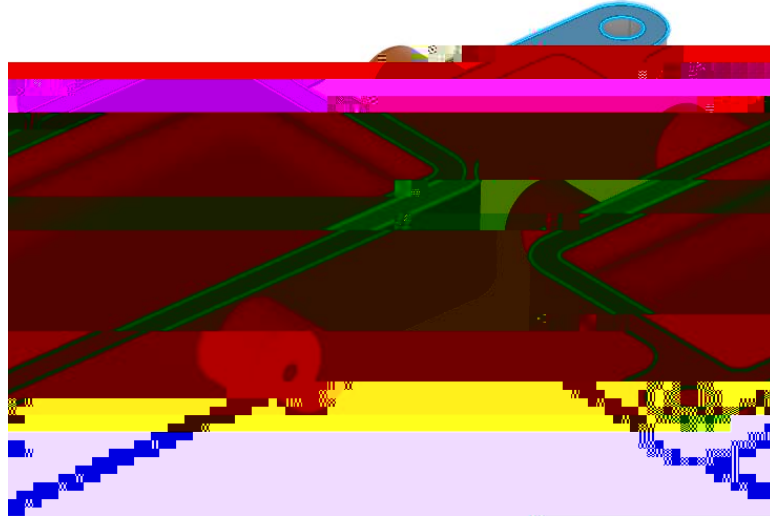

Change the *Name* to **Connection Face**, then select the face shown below for both the *Representation* and *Contact* elements. This will define the cavity connection point.



Select **OK**. You are now ready to define the connector connection points.

Select the  icon, then select the connector. The first connection point to define will be for the input.

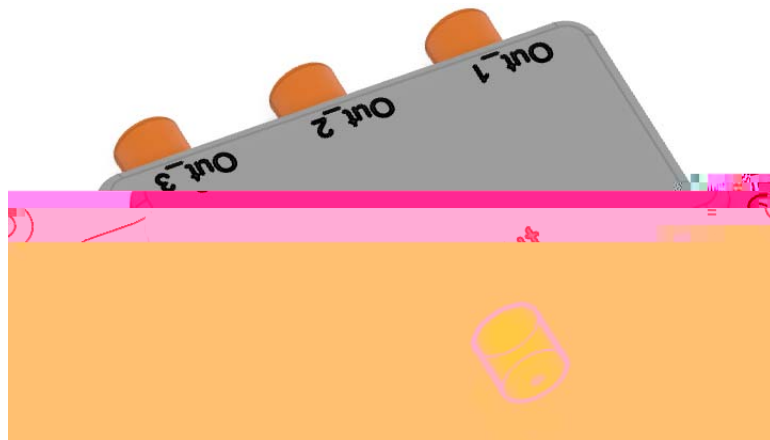
Change the *Name* to **Input** and select the cylinder for the *Representation*. This surface is shown below.



Select the front face of the connector as the *Contact* placement constraint. Again, this surface is shown.

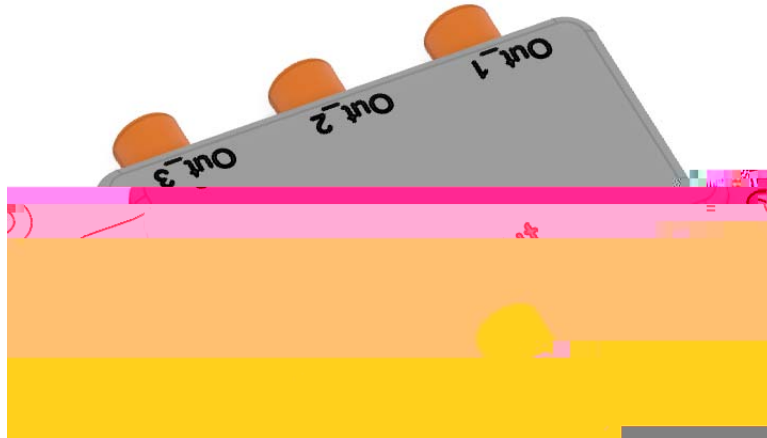

Select the centerline of the connector for the *Coincidence* field, then select *OK*.

Feel free to define the other 3 connector connection points in the same manner.

## 9`YWhf]WU` ` 8`8Yg][ b

The Electrical 3D Design workbench provides the ability to electrically assemble devices together. All of the various connection points that have been discussed will ensure that the proper connections and relations exist between electrical parts. Keep in mind that, unless all electrical placement constraints have been defined, the components might not fully come together. There may also be parts in electrical assemblies that do not have, nor need, electrical properties. Any parts that do not fully assemble in the model will need assembly constraints to tie them together. The main goal is the ability to electrically relate assembled parts.

## 5ggY a V`]b [ `9`YWhf]WU` ` 8Y j]WYg

You will assemble a gauge that has a series of parts and connections associated with it.

**Create a new product called ELEC030 - Electrical Gauge.**

**Press the third mouse button on the *ELEC030 - Electrical Gauge***



Press the third mouse button on *ELEC030 - Light* in the tree and select *Properties*. The *Properties* window appears.

Select the *Electrical* tab. The light has been defined as a *Single Insert Connector*.

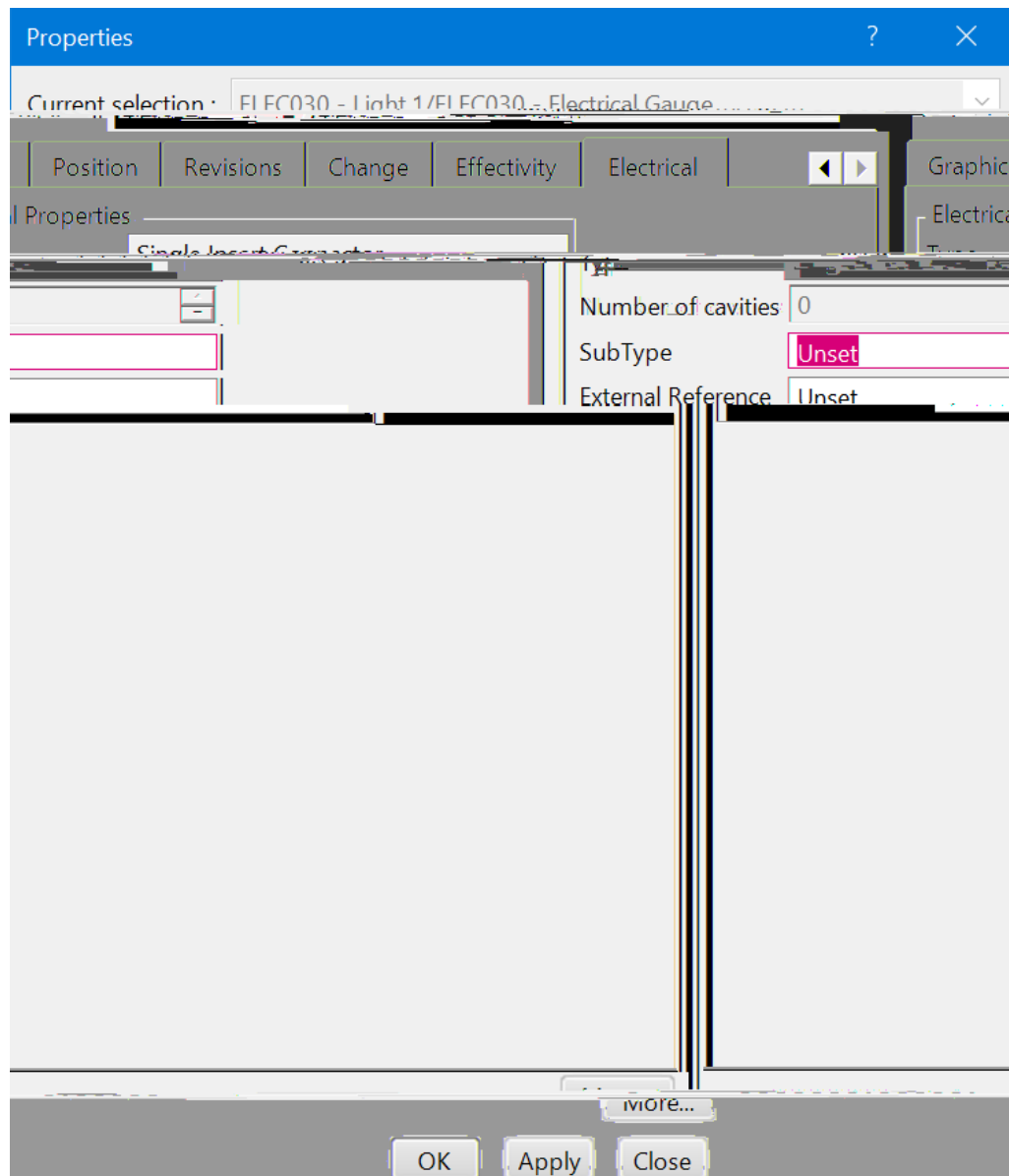



All three placement constraints are defined. If you were to show *Line.1* and *Line.2*, you would find they make a T shape at the bottom of the light to allow for a coincidence on the centerline and an orientation of the socket.

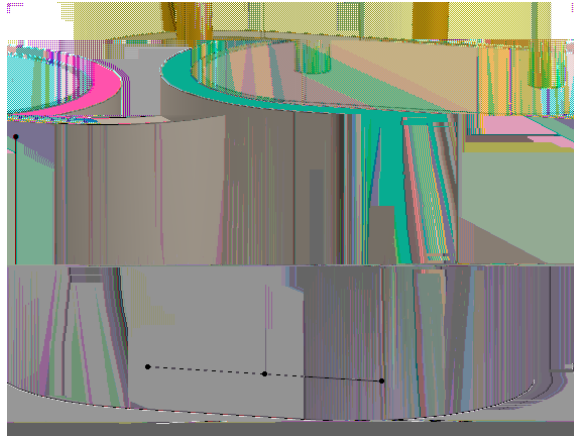

*Note: The lines are displayed above for illustration purposes; they do not need to be shown.*

Many times, to define all three placement constraints, additional geometry must be created.

**Select *Cancel* to the *Cavity Connection Point Definition* window, then double-select on the *ELEC - Electrical Gauge* product at the top of the specification tree.** This will activate the product again.

**Check the electrical properties of *ELEC030 - Socket* to determine which type of device it is.**

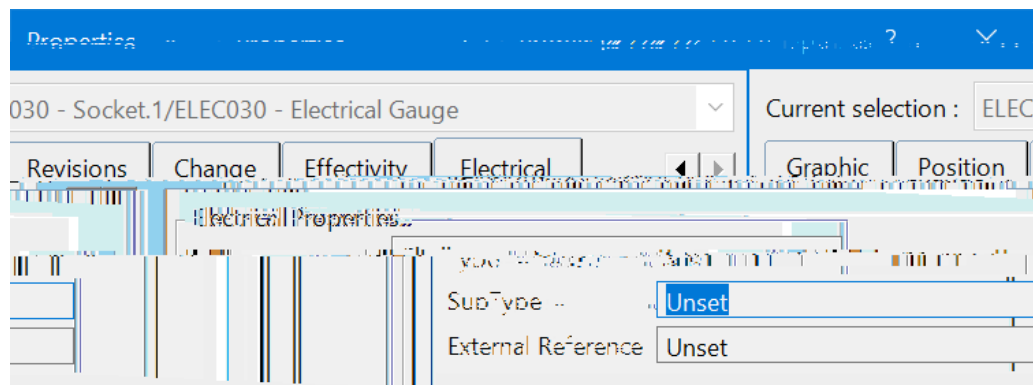

The socket is a shell. Shells are allowed to connect via a cavity and a cavity connection point.

Close the *Properties* window and examine the electrical connections in the socket part.

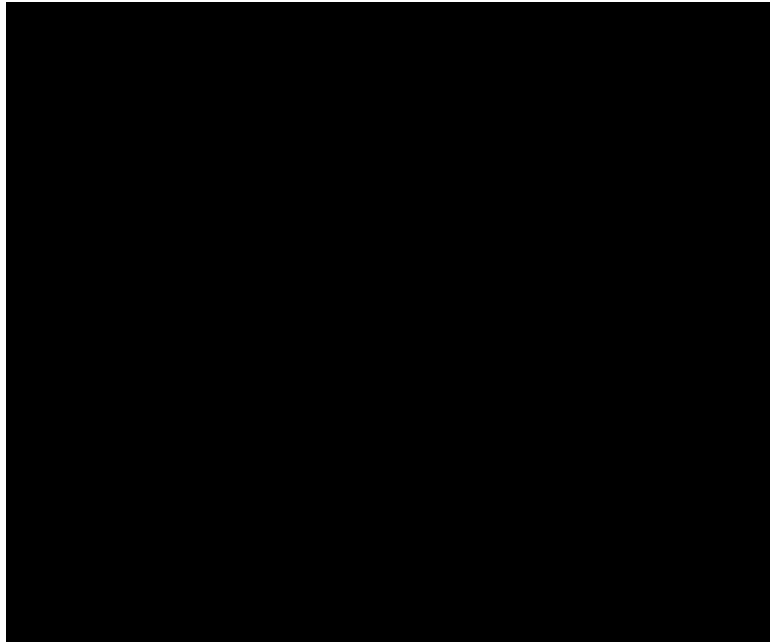

This shell has three electrical connections. A cavity is defined inside the hole of the shell. It also has the same T shape, which is defining the same placement constraints.

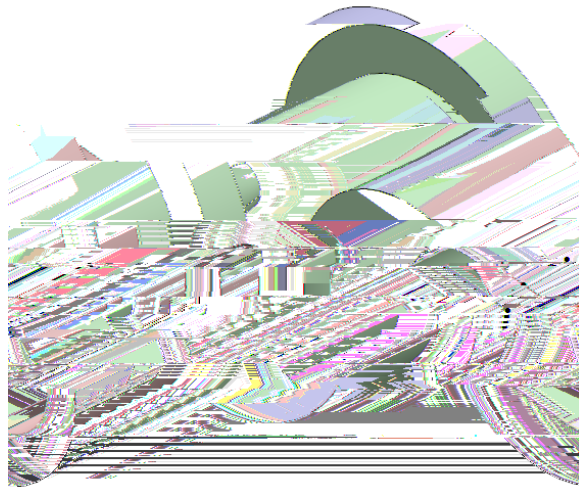

Now you are ready to electrically assemble the two items together.

Ensure you are in the **Electrical 3D Design** workbench, then select the **7 cbbYWh 8Y jJWYg** icon from the *Device* section.  This will electrically connect two devices together via their connection points.

**Select the light from the workspace.** This will indicate that you are connecting the light to another device.



# *CATIA Electrical Design*

**9`YWhf]WU`5ggY a V m`7 cbghfU]bhg**

When two devices are electrically connected, an engineering connection is created to hold the parts together. The type of engineering connection created is based upon the *Contact*, *Coincidence*, and *Orientation* elements specified during the connection point definition. These elements constrain to each other when the two parts have been defined. If one device has an *Orientation* element specified and the other does not, a constraint will be missing, whio e o s i \$ \$ enes aen defi nedec

W\SH CWZR SL\HSDRQ WKH Orientation HOHT0P @ pp0 @•À`€p0 @€`0p [0p€`

**Select the**

